

# ISOFLEX MOUNT DATA SHEET

## M100-24 B

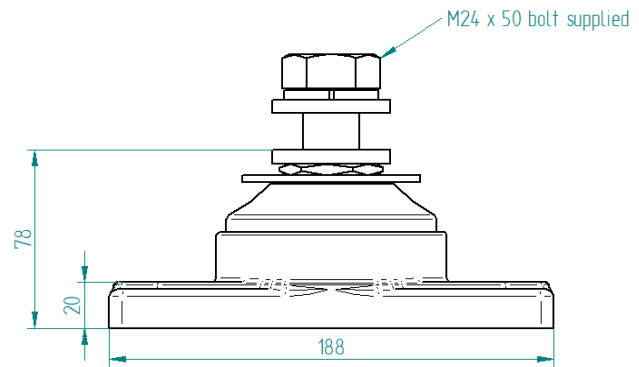
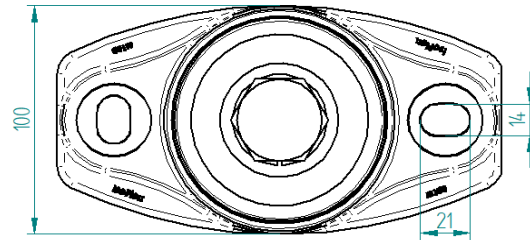

### IDENTIFICATION:

M100	Model number
24	Thread size
B	Bolt type

### Resilient Element Shore Durometer Color Hardness

	A-scale (SDH-A)
Red	60
Black	70
Light Blue	72
Dark Blue	75
Green	80

Other duro available on request

### DIMENSIONS:

	Metric (mm)	Imperial (in)
Mount Height	78	3.07
Overall length	188	7.40
Overall width	100	3.94
Mount spacing length	140	5.51
Mount hole width	14	0.55
Mount hole length	21	0.83

### Base: Black - 75 SDH-D

Metal components a combination of marine alloy, stainless steel and components zinc plated to ASTM B633 Type II SC3

# ISOFLEX MOUNT DATA SHEET

## M100-24 B

### Loading Type: Axial - Vertical Down (A-direction)

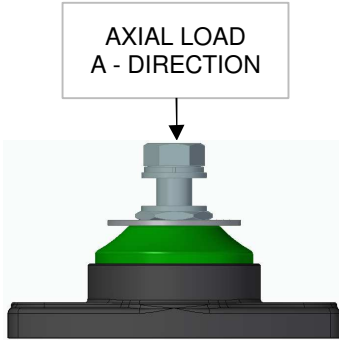

Resilient Element Colour	Shore Durometer Hardness A-Scale (SDH-A)	Axial Spring Rate @ 2mm	
		kg/cm	lb/in
Red	60	370	2072
Black	70	540	3024
Light Blue	72	600	3360
Dark Blue	75	880	4928
Green	80	1380	7728

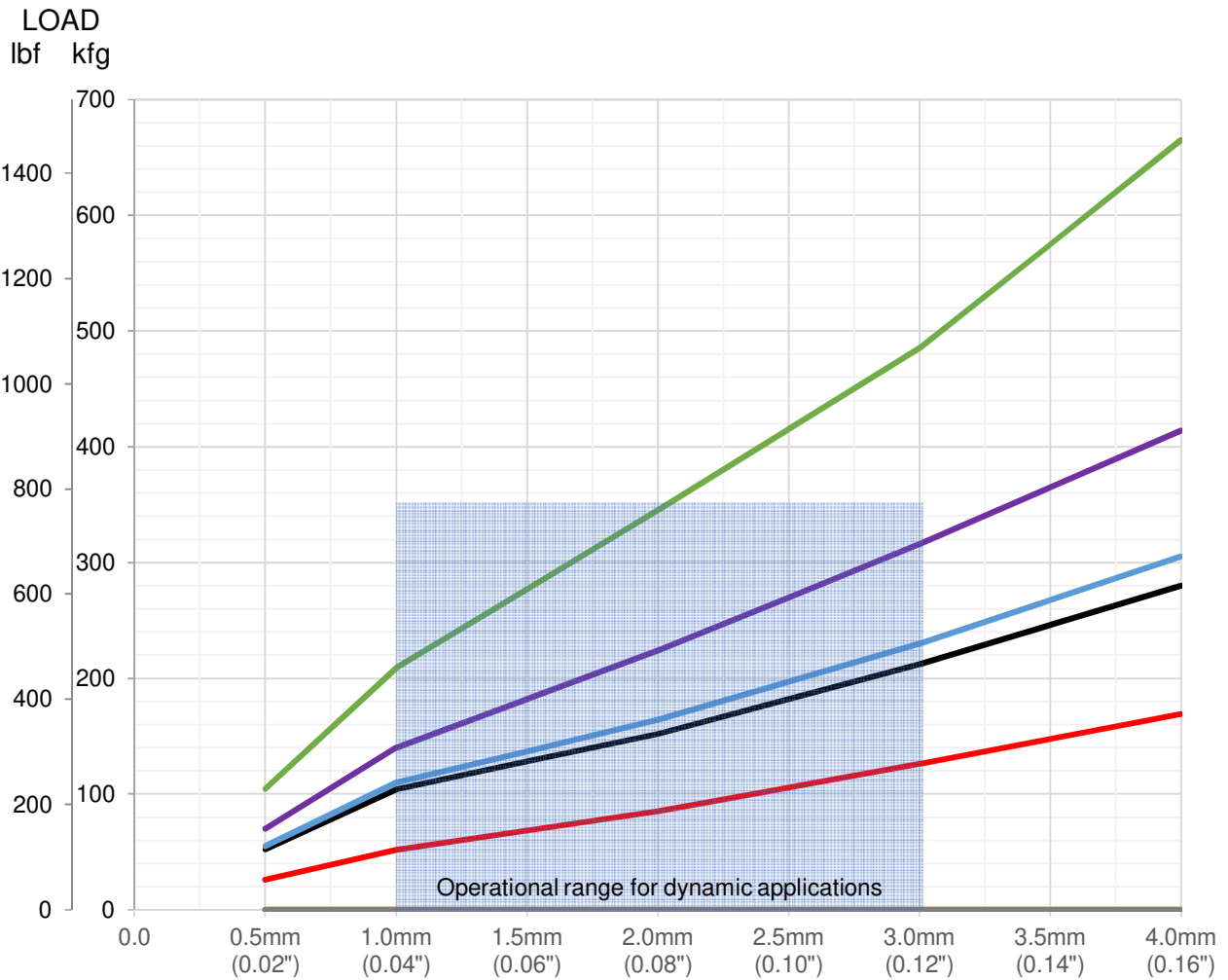

**Graph: Static Axial Vertical Load [kg] (lb) versus Deflection [mm] (in)**

Note: Stated spring rate average taken @ 2mm compression

# ISOFLEX MOUNT DATA SHEET

## M100-24 B

### Loading Type: Longitudinal Thrust (T-direction)

LONGITUDINAL THRUST  
T - DIRECTION

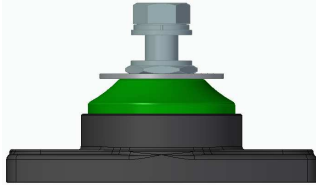

Resilient Element Colour	Shore Durometer Hardness A-Scale (SDH-A)	Axial Spring Rate @ 2mm	
		kg/cm	lb/in
Light Blue	72	1930	10808
Dark Blue	75	2000	11200
Green	80	2075	11620

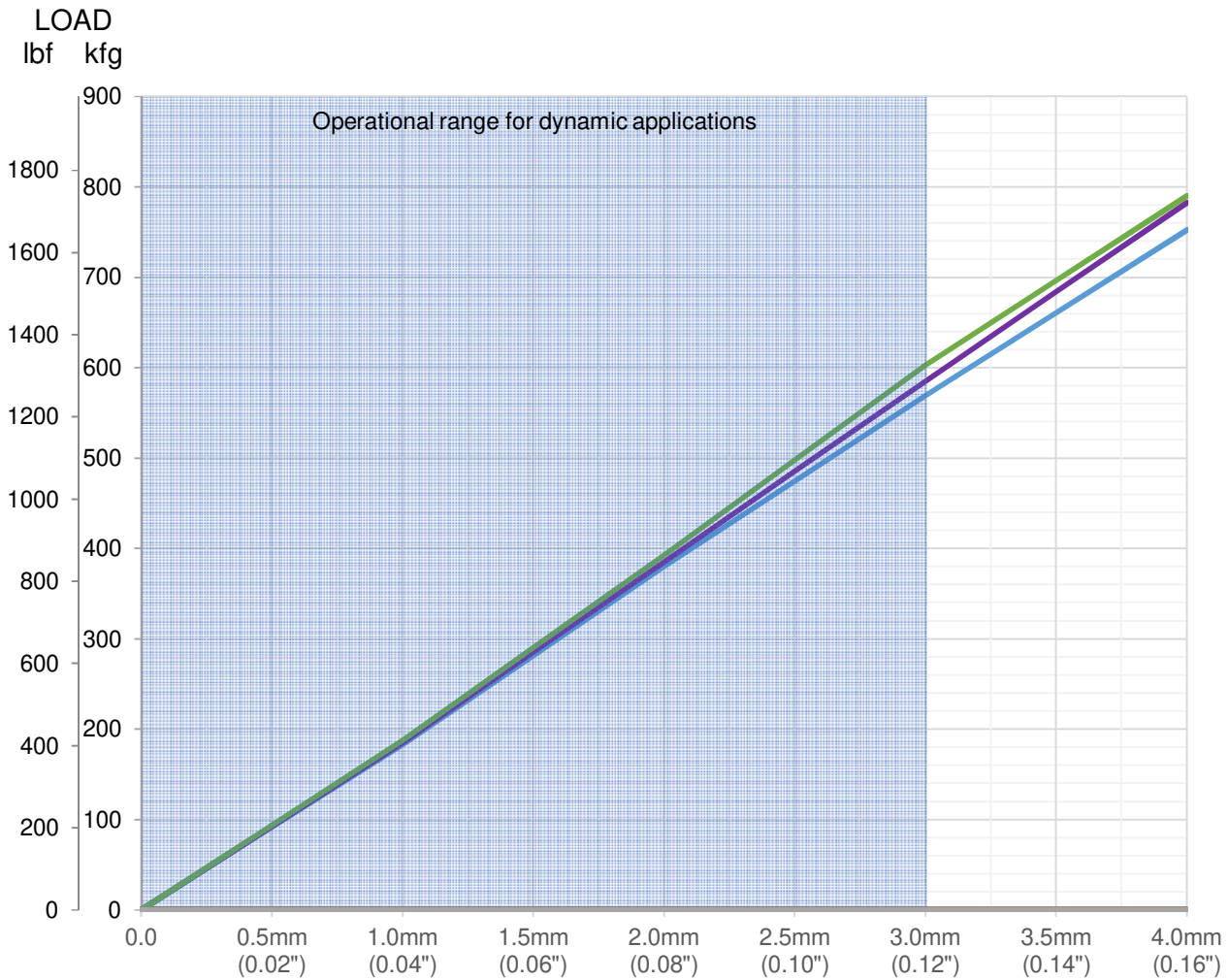

**Graph: Static Longitudinal Load [kg] (lb) versus Deflection [mm] (in)**

Note: Stated spring rate average taken @ 2mm deflection with 2.5mm compression pre load

# ISOFLEX MOUNT DATA SHEET

## M100-24 B

### Loading Type: Lateral (L-direction)

LATERAL LOAD  
L- DIRECTION



Resilient Element Colour	Shore Durometer Hardness A-Scale (SDH-A)	Axial Spring Rate @ 2mm	
		kg/cm	lb/in
Light Blue	72	1418	7938
Dark Blue	75	1625	9100
Green	80	1685	9436

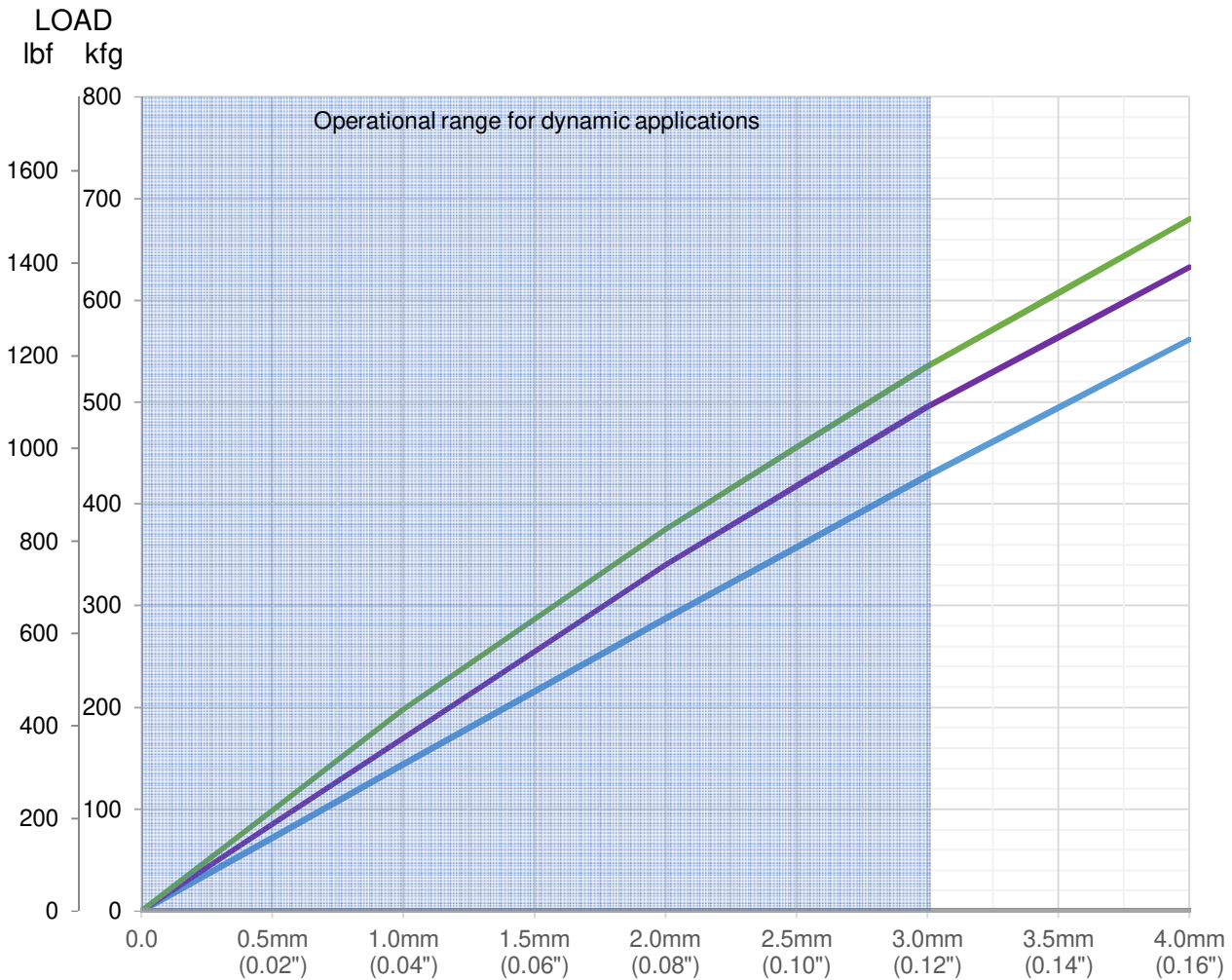

**Graph: Static Lateral Load [kg] (lb) versus Deflection [mm] (in)**

Note: Stated spring rate average taken @ 2mm deflection with 2.5mm compression pre load